



PVC-LINK®
Symbol of Wiring

Our Group

Megapower was incorporated in Malaysia in 1990 as a supplier of PVC cable management system and wiring accessories. By continuous expansion, Megapower is now well equipped with its in-house facilities for plastic extrusion and injection, which include tooling, testing and production technologies such as compounding, on-line and off-line finishing, down-stream engineering and packaging.

Megapower has joint ventured with Legrand France in November 2011. Legrand is a worldwide specialist in electrical and infrastructure for buildings with products ranging from wiring devices, circuit breakers and capacitors to datacom solutions and automated lighting controls.

The association of our two companies has provided a strong base to continue to expand the growth of both companies and reflects our long term commitment to mutual success.

Our Marketing

Megapower is successful in expanding its sales and marketing network throughout Malaysia and also the South East Asia Region with its own house brand, **SAGA** (Heavy Duty), **PVC-LINK** (Heavy Duty), **TND** (Heavy Duty), **WIREMAN** (Medium Duty), **MEGA** (Medium Duty), **MP** (Medium Duty), **CYBER** (Light Duty) and **HERO** (Light Duty).

Megapower remains to cater to **OEM** customers with customer's brands specifications in the Middle East, South East Asia, Australia and Europe.

Apart from its own products, Megapower is appointed as an exclusive distributor for Legrand and as well as a few global brand's electrical products in Malaysia.



Our Mission

Megapower aims to be a one-stop center in Non-metallic (Plastic) electrical cable management systems and wiring accessories. Megapower main concerns are in COST EFFECTIVENESS, EFFICIENCY and most importantly, QUALITY.

Our Quality Achievements

- **SIRIM Certified**
 - Quality Assurance Scheme Licensee
- **JKR Approved**
 - Product approval for PVC Conduits and Fittings.



Cable Slab - Angle

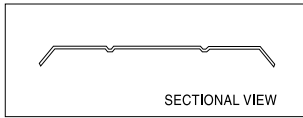
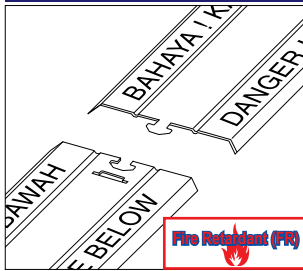

Ref.No.	Size mm
PCS250A	250
Colour : Green (LV) / Orange (HV)	
* Other colours and wording available upon request.	
Length : 1m	

Embossed word:
 Top : BAHAYA! KABEL LETRIK DI BAWAH
 Bottom : DANGER! ELECTRIC CABLE BELOW

Cable Slab - Flat

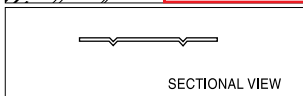
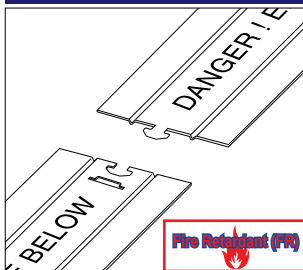

Ref.No.	Size mm
PCS120F	120
PCS150F	150
PCS200F	200
Colour : Green (LV) / Orange (HV) / White / Yellow / Black	
* Other colours and wording available upon request.	
Length : 1m	

Embossed word:
 Centre : DANGER! ELECTRIC CABLE BELOW

Hazard Tape

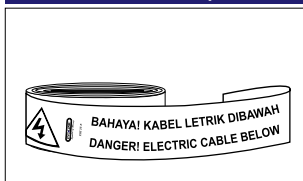

Ref.No.	Width (mm)	Length (m)
PHT 3YE	75	610
PHT 6YE	150	305
PHT 6O-T	150	305
Colour : Yellow / Orange		
* Other colours and wording available upon request.		

PVC-LINK® High Impact uPVC Cable Slab

is manufactured from specially formulated high impact polyvinyl chloride to provide the highest impact and tensile strength for the protection of underground cable or piping. It's ultimate interlocking linkage system will ensure the retention of the protection chain even under severe earth movement or impact.

ADVANTAGES

Long term protection

- PVC is chemically inert to the acidic, saline and alkaline conditions found in certain soils.

Permanent identification and appearance

- Embossed lettering and different bright colours in the plastic material ensures a permanent means of identification and visibility during darkness.

Total flexibility

- The linked chain can be turned to follow the path of the laid service run.

Low storage and transportation costs

- Up to 2 km of Cover Plates can be stored on one pallet (ratio 1:20 of bricks)

Low installation cost

- A single person can handle the laying of the plates without even entering the dug trench.

Cable Slab

Orange - High voltage

Green - Low voltage

Hazard Tape

Yellow - Electric

Printed : BAHAYA! KABEL LETRIK DI BAWAH

DANGER! ELECTRIC CABLE BELOW

Orange - Telecommunication

Printed : AWAS! AWAS! AWAS!

KABEL TELEKOM DI BAWAH

HUBUNGI TELEKOM: TEL.100



High Impact Rigid Conduit

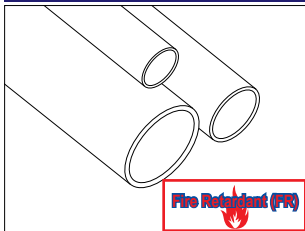

Ref.No.	Size mm
P H20	20
P H25	25
P H32	32
P H40	40
P H50	50
Colour : White / Orange / Black	
* Other colours and wording available upon request.	
Length : 2.9m	

PVC-LINK® High Impact uPVC Conduit is manufactured from specially formulated high impact polyvinyl chloride in strict accordance to meet the requirement of BS EN 61386-21:2004, +A11:2010 MS 61386-21:2010 (Heavy Duty 4421)

Certified:



Product Certification Licence.

Corrugated Conduit

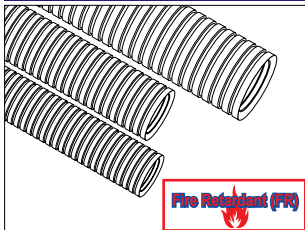

Ref.No.	Size mm
PCC 20	20
PCC 25	25
Colour : White / Orange / Black	
* Other colours and wording available upon request.	
Coil : 50m	

PVC-LINK® Corrugated Conduit is manufactured by polyvinyl chloride specially formulated to provide the highest flexibility and meet the requirement of BS EN 61386-23:2008



Corrugated Conduit

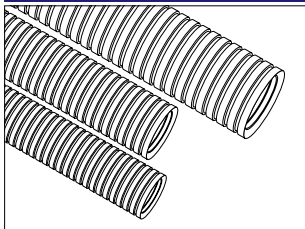

Ref.No.	Size mm	Coil/m
PCC 7	7*	300
PCC 10	10*	200
PCC 16	16	50
PCC 32	32	25
PCC 40	40	25
PCC 50	50	25
Colour : White / Black		
Black only*		
* Other colours and wording available upon request.		

PVC-LINK® Corrugated Conduit is produced from specially formulated excellent thermoplastic material to provide the highest flexibility.



Corrugated Conduit Adaptor

(Screw Type)

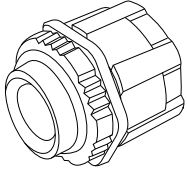

Ref.No.	Size mm
PCCA 16	16*
PCCA 20	20
PCCA 25	25
PCCA 32	32*
PCCA 40	40*
PCCA 50	50*
Colour : White / Orange / Black	
Black only*	

Corrugated Conduit Adaptor

(Clip Type)

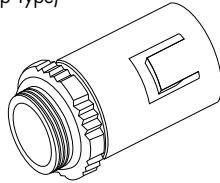

Ref.No.	Size mm
PCCAC 20	20
PCCAC 25	25
Colour : White / Orange / Black	

Dome Cover

(Clip Type)

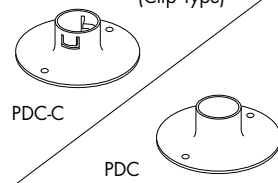

Ref.No.	Size mm	Diameter mm
PDC 20	20	65
PDC 25	20	65
PDC-C 20	20	65
PDC-C 25	25	65
Colour : White / Orange / Black		

Loop In Box

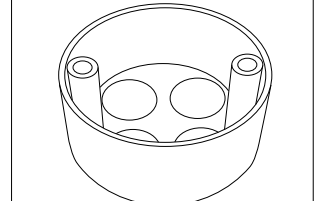

Ref.No.	Size mm	Diameter mm
PCLIB	20	65
Colour : White / Orange / Black		

Terminal One Way Box

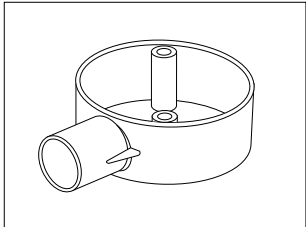

Ref.No.	Size mm	Diameter mm
PCB 20-1	20	65
PCB 25-1	25	65
PCB 32-1	32	75
Colour : White / Orange / Black		

Through Two Way Box

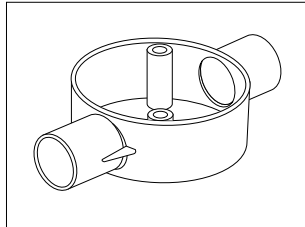

Ref.No.	Size mm	Diameter mm
PCB 20-2	20	65
PCB 25-2	25	65
PCB 32-2	32	75
Colour : White / Orange / Black		

Angle Two Way Box

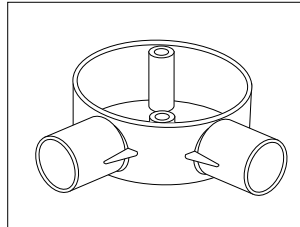

Ref.No.	Size mm	Diameter mm
PCB 20-2A	20	65
PCB 25-2A	25	65
PCB 32-2A	32	75
Colour : White / Orange / Black		

Corrugated & Conduit Connector

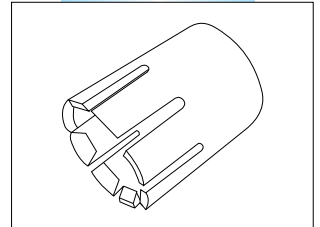

Ref.No.	Size mm
PCCC 20	20
PCCC 25	25
Colour : White / Black	

Tee Three Way Box

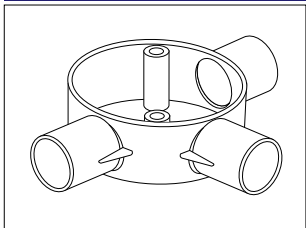

Ref.No.	Size mm	Diameter mm
PCB 20-3	20	65
PCB 25-3	25	65
PCB 32-3	32	75
Colour : White / Orange / Black		

Intersection Four Way Box

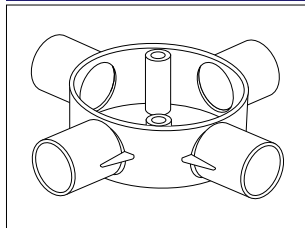

Ref.No.	Size mm	Diameter mm
PCB 20-4	20	65
PCB 25-4	25	65
PCB 32-4	32	75
Colour : White / Orange / Black		

U, Y, H Way Box

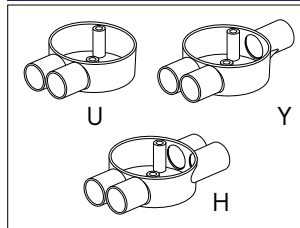

Ref.No.	Size mm	Diameter mm
PCB 20-U	20	65
PCB 20-Y	20	65
PCB 20-H	20	65
Colour : White / Orange / Black		

Extension Ring

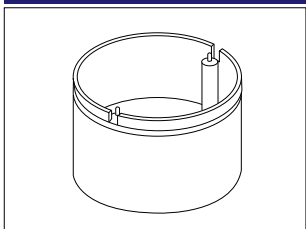

Ref.No.	Height mm	Diameter mm
PER-L	25	65
PER-H	38	65
PER-H50	50	65
Colour : White / Black		

Lid Cover

(Screw Type)

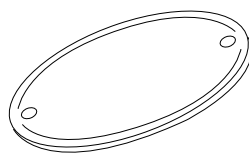

Ref.No.	Size mm	Diameter mm
PLC	20 & 25	65
Colour : White / Orange / Black		

Protector Cover

(Clip Type)

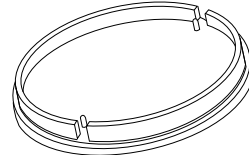

Ref.No.	Size mm	Diameter mm
PPC	20 & 25	65
PPC 32	32	75
Colour : White / Orange / Black		



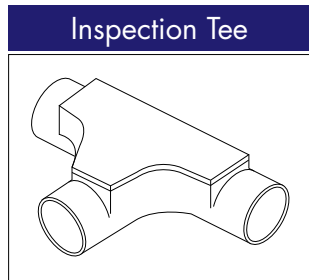

Ref.No.	Size mm
PIT 20	20
PIT 25	25
PIT 40	40

Colour : White / Orange / Black

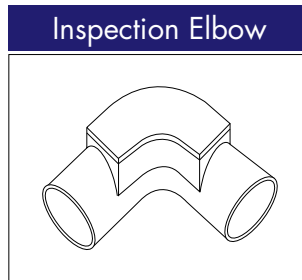

Ref.No.	Size mm
PIE 20	20
PIE 25	25

Colour : White / Orange / Black

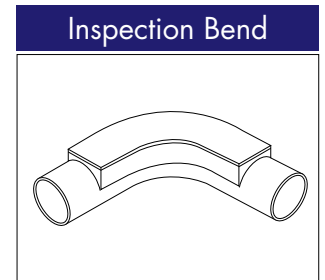

Ref.No.	Size mm
PIB 20	20
PIB 25	25

Colour : White / Orange / Black

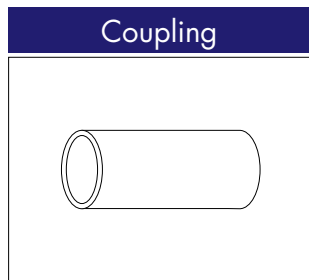

Ref.No.	Size mm
PC 20	20
PC 25	25
PC 32	32
PC 40	40
PC 50	50

Colour : White / Orange / Black

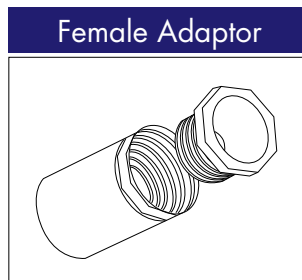

Ref.No.	Size mm
PFA 20	20
PFA 25	25
PFA 32	32

Colour : White / Orange / Black

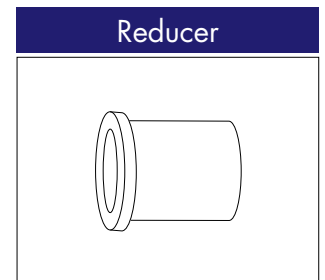

Ref.No.	Size mm
PR 20	25-20
PR 25	32-25

Colour : White / Orange / Black

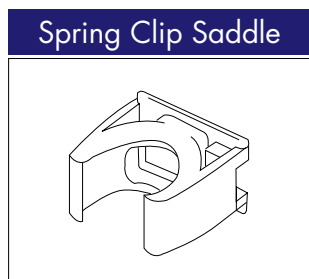

Ref.No.	Size mm
PSCS 20	20
PSCS 25	25
PSCS 32	32

Colour : White / Orange / Black

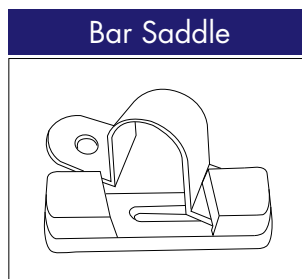

Ref.No.	Size mm
PBS 20	20
PBS 25	25
PBS 32	32
PBS 40	40

Colour : White / Orange / Black

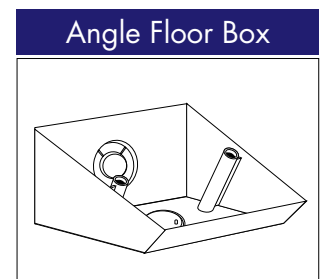

Ref.No.	Size
PAFB-1	1Gang*
PAFB-2	2Gang*
PAFB-3	2x1 Gang*

Colour : White / Orange / Black
*Unbreakable Polycarbonate
Version available upon request

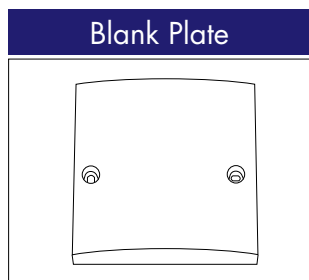

Ref.No.	Size
PBP-1	1Gang
PBP-2	2Gang

Colour : White

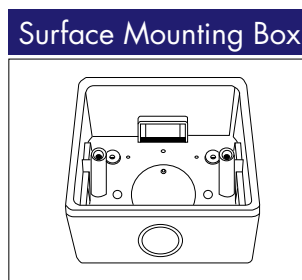

Ref.No.	Size
PSMB-1	1Gang
PSMB-2	2Gang
PSMB-3	2x1Gang
PSMB-4	3x1Gang
PSMB-5	4x1Gang

Colour : White

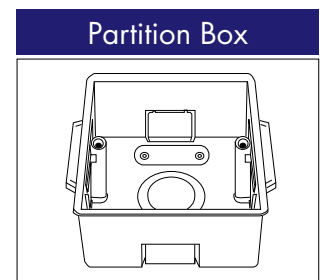

Ref.No.	Size
PPB-1	1Gang
PPB-2	2Gang
PPB-3	2x1Gang

Colour : White



Concealed Box Cover

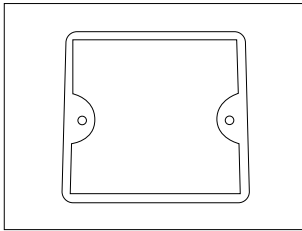

Ref.No.	Size
PKOBC-1	1Gang
PKOBC-2	2Gang
Colour : White	

Concealed Box

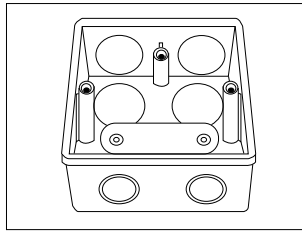

Ref.No.	Size
PKOB-1	1Gang
PKOB-2	2Gang
PKOB-3	2x1Gang
Colour : White / Black	

Concealed Box

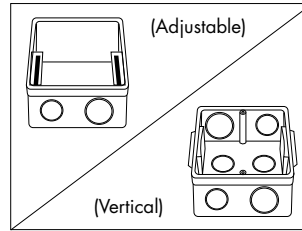

Ref.No.	Size
PKOB-1A	1Gang
PKOB-1V	1Gang
PKOB-3A	2x1Gang
Colour : White / Black	

Connectable Concealed Box

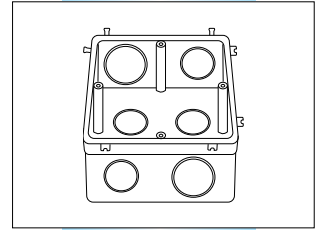

Ref.No.	Size
PKOB-1C	1Gang
Colour : White / Black	

Astro / Satellite Socket Outlet

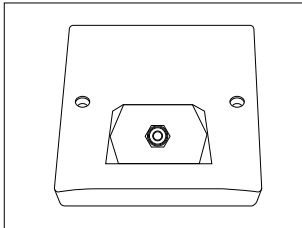

Ref.No.	Size
PAS-1	1Gang
Colour : White	

Meter Block

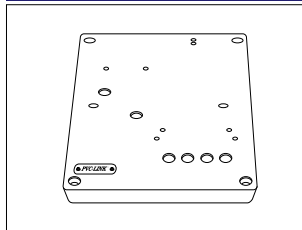

Ref.No.	W x H mm
PMB 910	250 x 225
Colour : White	

Fan Regulator Board

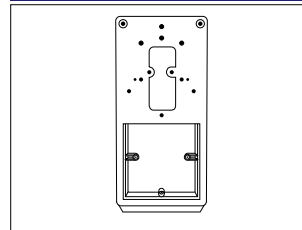

Ref.No.	W x H mm
PFRB 410	97 x 225
Colour : White	

Wall Plug

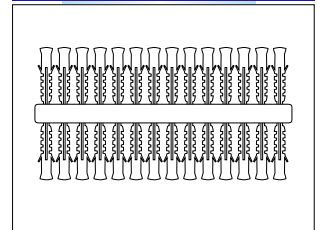

Ref.No.	Size mm
PWP 6	6
Colour : Black / Blue / Yellow	

MCB Spacer

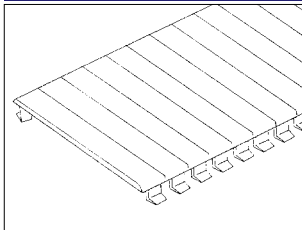

Ref.No.	Way	L x W x H mm
PMS	12	215 x 53
Colour : White		

Weatherproof Protective Cover

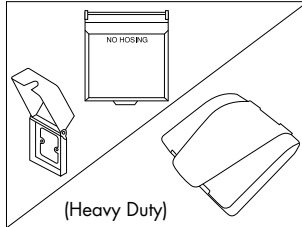

Ref.No.	Size
PWPC-1	1Gang
PWPC-1-HD	1Gang Heavy Duty
PWPC-2	2Gang
Colour : White / Transparent / Smokey	

Solid Bend

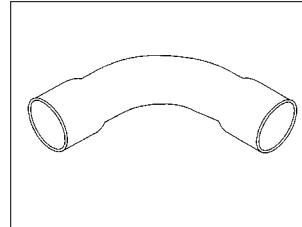

Ref.No.	Size mm
PSB 32	32
PSB 40	40
PSB 50	50
Colour : White / Orange / Black	

S - Solid Bend

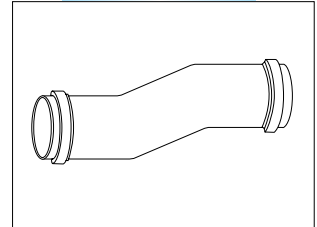

Ref.No.	Size mm
PSCO 25	25
Colour : White	

MCB Box

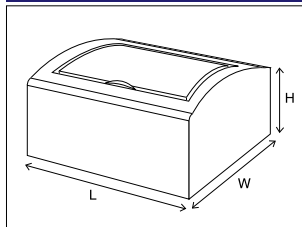

Ref.No.	Way	L x W x H mm
PL 06-10	10	222x146x98
PL 08-12	12	256x176x98
PL 12-16	16	327x176x98
PL 15-19	19	381x176x98
PL 19-23	23	454x176x98
PL 28	28	290x370x120
PL 42	42	290x495x120
PL 45	45	455x315x110
Colour : White / Transparent / Smokey cover		

ELCB / MCB Box

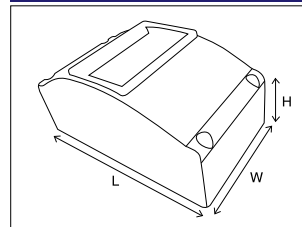

Ref.No.	Way	L x W x H mm
PLE 2	2	150x48x70
PLE 4	4	150x84x70
Colour : White		



*** Fire Retardant / Concealed type available upon request.**

Wire Puller

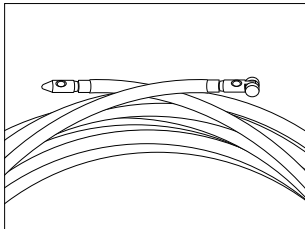

Ref.No.	Length m	Diameter mm
PWP 4515	15	4.5
PWP 4530	30	4.5
PWP 4550	50	4.5
PWP 45100	100	4.5
Colour : White / Orange / Black		

Almighty Reel - 1 Gang

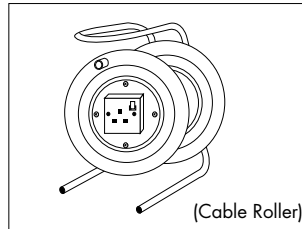

Ref.No.	Diameter mm
PAR-EC8	215
PAR-EC11	275
PAR-EC14	356
Colour : Black	
Frame : Steel	

13A Main Tester

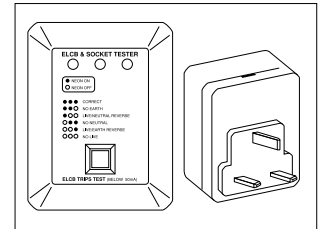

Ref.No.	ELCB Tester
PMT 13E	150MA
PMT 13E-300	300MA
Colour : White / Blue	

Earth Tape Clip

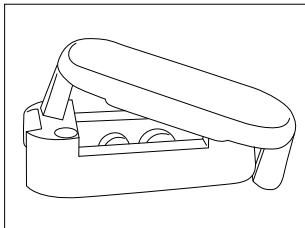

Ref.No.	Size mm
PETC	25
Colour : Brown / Orange	

Earth Chamber

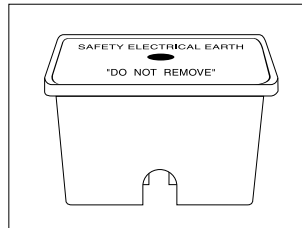

Ref.No.	L x W x H mm
PEC	175 x 175 x 90
Colour : Black	

Heavy Duty Earth Chamber

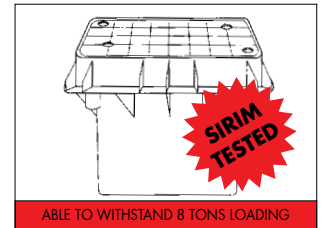

Ref.No.	L x W x H mm
PEC-HD	300 x 300 x 210
Colour : Black	

Bending Spring

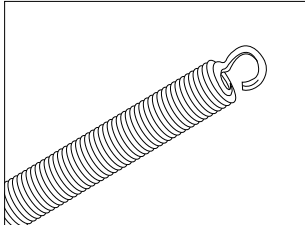

Ref.No.	Size mm	Spring
PS 20*	20	round
PS 25*	25	round
PS 32*	32	round
US 20	20	square
US 25	25	square
US 32	32	square
Treatment : Zinc Plated*		

Telecommunication Wire Puller

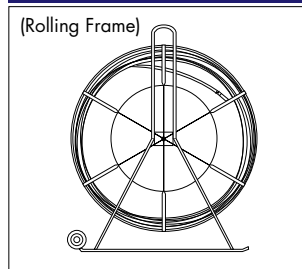

Ref.No.	Length m	Diameter mm
PTWP-120-F	120	11
PTWP-150-F	150	11
PTWP-225-F	225	11
PTWP-260/14-F	260	14
PTWP-305/14-F	305	14
Colour : Orange		

Line Tap

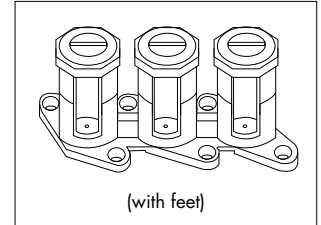

Ref.No.	Size mm
PLT 16	16
PLT 25	25
PLT 35	35
PLT 50	50
PLT 70	70
Colour : White	



Weatherproof Enclosure Box IP66

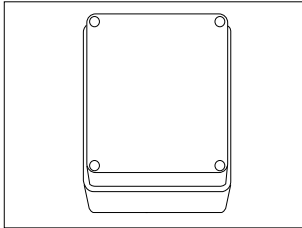

Ref.No.	L x W x H mm
PEB 442	110 x 110 x 60
PEB 444	110 x 110 x 110
PEB 643	155 x 115 x 80
PEB 644	155 x 115 x 110
PEB 863	215 x 150 x 80
PEB 864	215 x 150 x 110
PEB 883	215 x 215 x 80
PEB 884	215 x 215 x 110
PEB 1084	250 x 200 x 110
PEB 1086	250 x 200 x 160
PEB 1296	310 x 230 x 145
PEB 15127	390 x 310 x 180
PEB 18155	465 x 385 x 140

Colour : Light Grey / Transparent cover

- ABS thermoplastic
- IP66 Dust/weatherproof
- High impact strength
- Temperature range from -5°C ~ +70°C
- Chemical resistance to aqueous acids, alkalis, seawater, concentrated phosphoric & hydrochloric acid
- Polycarbonate version available upon request

Weatherproof Cable PG Gland IP68

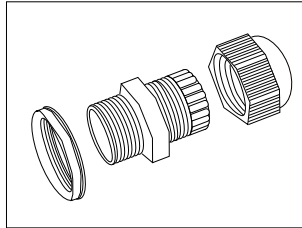

Ref.No.	Cable Diameter mm	Mounting Hole mm
PPG-7	3 - 6	13
PPG-9	4 - 8	16
PPG-11	5 - 10	19
PPG-13.5	7 - 12	20
PPG-16	10 - 14	23
PPG-21	13 - 18	29
PPG-29	18 - 25	37
PPG-36	22 - 32	48
PPG-42	30 - 38	54
PPG-48	34 - 44	60
PPG-63	42 - 50	73

Colour : Light Grey

Weatherproof Cable M Gland IP68

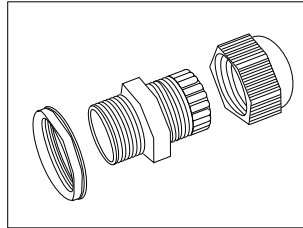

Ref.No.	Cable Diameter mm	Mounting Hole mm
PCG-M12	2.5 - 6.5	15
PCG-M16	3.5 - 10	19
PCG-M20	6 - 13	23
PCG-M22	7 - 15	25
PCG-M25	8 - 18	28
PCG-M32	14 - 25	35
PCG-M40	18 - 32	43
PCG-M53	25 - 40	56
PCG-M58	30 - 45	61

Colour : Light Grey / Black

Junction Box IP44

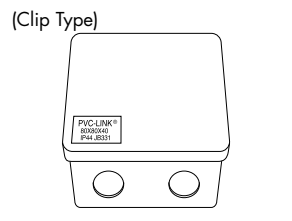

Ref.No.	L x W x H mm
PJB 331	80 x 80 x 40

Colour : Light Grey

FIRST NUMBER - Protection against solid objects

IP	TEST	DESCRIPTION
0	no protection	protected against solid objects over 1 mm (tools + small wires)
1	protected against solid objects up to 50 mm e.g. accidental touch by hands	
2	protected against solid objects up to 12 mm e.g. fingers.	
3	protected against solid objects over 2.5 mm (tools + small wires)	
4	protected against solid objects over 1 mm (tools + small wires)	
5	protected against dust - limited ingress permitted (no harmful deposit).	
6	totally protected against dust	

SECOND NUMBER - Protection against liquids

IP	TEST	DESCRIPTION
0	no protection	protected against low pressure jets of water from all directions - limited ingress permitted.
1	protected against vertically falling drops of water	
2	protected against direct sprays of water to 15° from the vertical.	
3	protected against spray to 60° from the vertical.	
4	protected against water sprayed from all directions limited ingress permitted.	
5	protected against strong jets of water e.g. for use on shipdecks - limited ingress permitted.	
6	protected against the effects of immersion between 1.5 cm and 1m.	
7	protected against long periods of immersion under pressure.	
8	protected against long periods of immersion under pressure.	



Rectangular Telephone Trunking

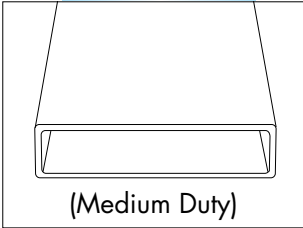

(Medium Duty)

Ref.No.	W x H mm
PPT 12	50 x 25
PPT 13	75 x 25
PPT 14	100 x 25
Colour : Grey	
Length : 3.65m	

Trapezoidal Telephone Trunking

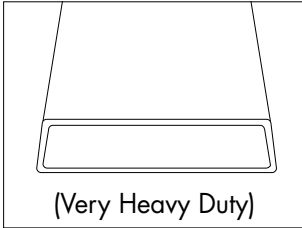

(Very Heavy Duty)

Ref.No.	W x H mm	Thickness mm
Very Heavy Duty		
PUFDT 225	50 x 25	2.5
PUFDT 332	75 x 25	3.2
PUFDT 432	100 x 25	3.2
Colour : White		
Length : 2.9m		

Rectangular Telephone Trunking

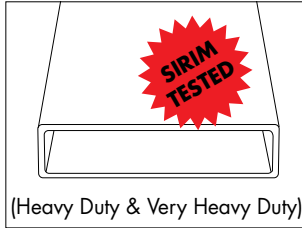

(Heavy Duty & Very Heavy Duty)

Ref.No.	W x H mm	Thickness mm
Heavy Duty		
PUFD 223	50 x 25	2.3
PUFD 325	75 x 25	2.5
PUFD 427	100 x 25	2.7
SIRIM TESTED		
Very Heavy Duty		
PUFD 225	50 x 25	2.5
PUFD 332	75 x 25	3.2
PUFD 432	100 x 25	3.2
Colour : White		
Length : 2.9m		

Rectangular Telephone Trunking - 38mm Height

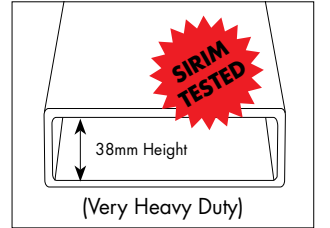

(Very Heavy Duty)

Ref.No.	W x H mm	Thickness mm
Very Heavy Duty		
PUFD 232H	50 x 38	3.2
PUFD 332H	75 x 38	3.2
PUFD 432H	100 x 38	3.2
SIRIM TESTED		
Colour : White		
Length : 2.9m		

S - End Bend

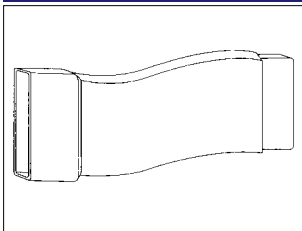

Ref.No.	W x H mm	Thickness mm
PSEB 332	75 x 25	3.2
Colour : White		

TNB Casing

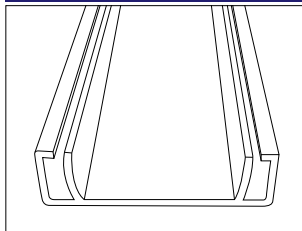

Ref.No.	W x H mm
PTC 2W-32	36 x 13
PTC 3W-40	45 x 13
PTC 4W-50	55 x 13
Colour : White	

TNB Clip & Junction Box

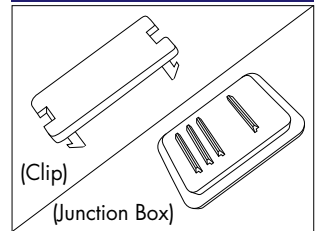

Ref.No.	W x L mm
PTCC 32	15 x 32
PTCC 40	15 x 45
PTCC 50	15 x 55
PTCJB	68 x 107
Colour : White	

Junction Box

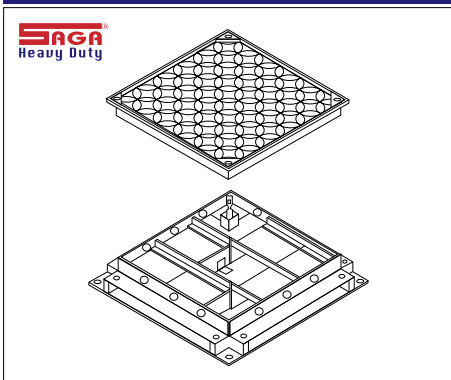

* Please refer to SAGA Catalogue for more details.

Service Box

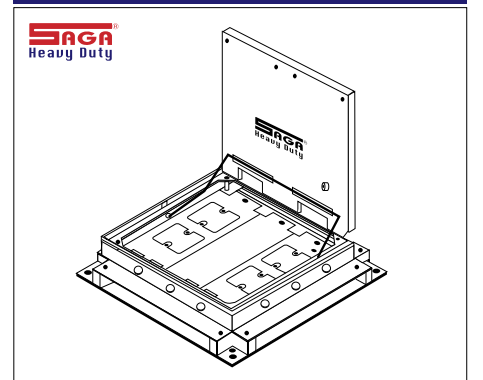

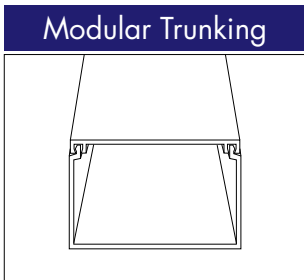

Ref.No.	W x H mm
PMT 3250	50 x 32
PMT 5550	50 x 55
PMT 5575	75 x 55
PMT 55100	100 x 55
PMT 75100	100 x 75
PMT 100100	100 x 100
PMT 100150	150 x 100
PMT 55200	200 x 55
PMT 100200	200 x 100
Colour : White	
Length : 1.83m, 2.00m, 2.44m & upon request	

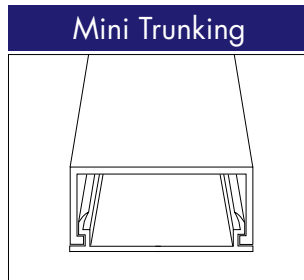

Ref.No.	W x H mm
PMT 1020	20 x 10
PMT 1327	27 x 13
PMT 1330	30 x 13
Colour : White	
Length : 1.83m, 2.00m & upon request	

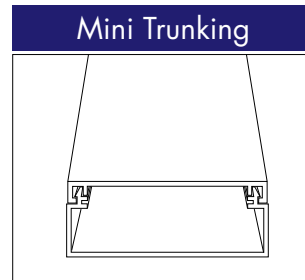

Ref.No.	W x H mm
PMT 1640	40 x 16
PMT 2040	40 x 20
PMT 1650	50 x 16
Colour : White	
Length : 1.83m, 2.00m & upon request	

PVC-LINK® uPVC Modular Trunking and Mini Trunking are manufactured from specially formulated polyvinyl chloride in strict accordance to meet the requirement of BS 4678 Pt.4. It offers a complete range for the routing of surface mounted cabling in domestic and commercial premises.

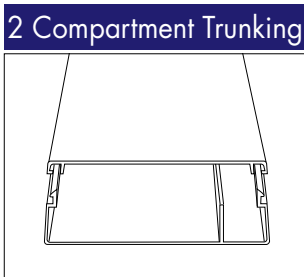

Ref.No.	W x H mm
PMT 2C 2040	40 x 20
PMT 2C 2060	60 x 20
PMT 2C 3280	80 x 32
Colour : White	
Length : 2m & upon request	

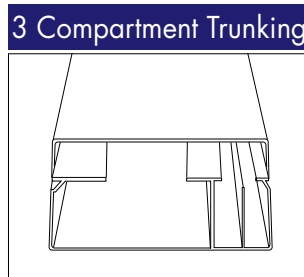

Ref.No.	W x H mm
PMT 3C 40100	100 x 40
Colour : White	
Length : 2m & upon request	

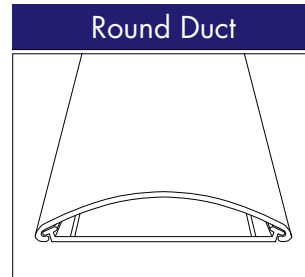

Ref.No.	W x H mm
PRD 30	30 x 8
PRD 50	50 x 13
PRD 70	70 x 15
PRD 90	90 x 22
PRD 120	120 x 30
Colour : Grey / Black / White / Yellow	
Length : 2.0m	

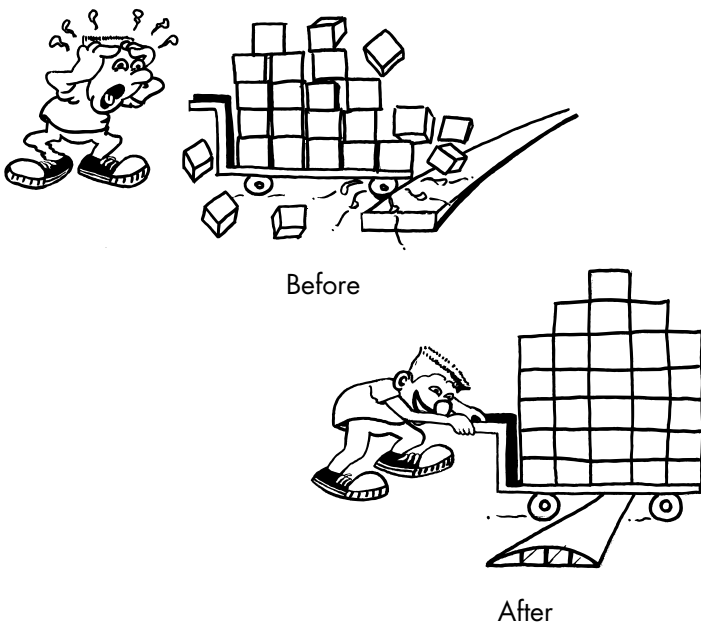

PVC-LINK® High Impact uPVC Round Duct is constructed from specially formulated high impact polyvinyl chloride. The distinctive design feature provides safe and secure cable management at all time.

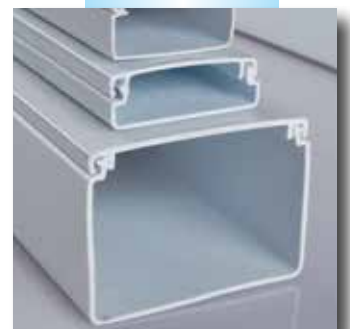

Watertight Flexible Conduit (EF Type)

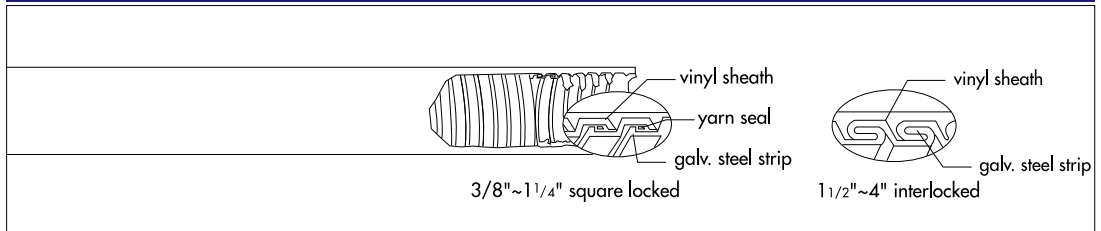

Ref.No.	Size inch	Vinyl Sheath Thickness mm	Min. Bending Radius mm	Coil/m
PBA 206703	3/8	1.0	60	50
PBA 206704	1/2	1.0	80	50
PBA 206706	3/4	1.0	100	30
PBA 206710	1	1.0	150	30
PBA 206712	1-1/4	1.5	180	20
PBA 206714	1-1/2	1.5	220	20
PBA 206720	2	1.5	250	15
PBA 206724	2-1/2	2.0	300	10
PBA 206730	3	2.0	450	10
PBA 206740	4	2.0	600	5

- Galvanized steel core, with flame retardant PVC coated.
- High flexibility, absolutely moisture-proof.
- Absorbs motion, vibration and bending indefinitely.
- Cord packing size form 3/8" through 1-1/4" by squarelocked. 1-1/2" through 4" by interlocked.
- Temperature range from - 10 °C ~ +70 °C.
- IP66 Dust / weatherproof.

Watertight Straight Adaptor

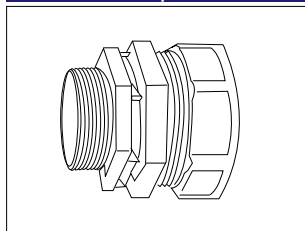

Ref.No.	Size inch	Thread
PBB 210103	3/8	mm/NPT
PBB 210104	1/2	mm/NPT
PBB 210106	3/4	mm/NPT
PBB 210110	1	mm/NPT
PBB 210112	1 1/4	NPT
PBB 210114	1 1/2	NPT
PBB 210120	2	NPT
PBB 210124	2 1/2	NPT
PBB 210130	3	NPT
PBB 210140	4	NPT

Watertight 90° Elbow Adaptor

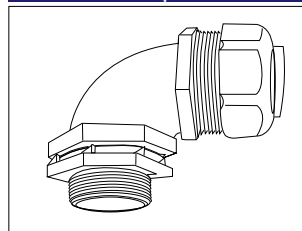

Ref.No.	Size inch	Thread
PBL 210103	3/8	NPT
PBL 210104	1/2	NPT
PBL 210106	3/4	NPT
PBL 210110	1	NPT
PBL 210112	1 1/4	NPT
PBL 210114	1 1/2	NPT
PBL 210120	2	NPT
PBL 210124	2 1/2	NPT
PBL 210130	3	NPT
PBL 210140	4	NPT

Watertight 45° Elbow Adaptor

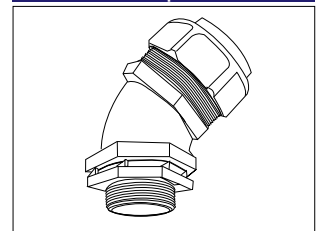

Ref.No.	Size inch	Thread
PBN 210103	3/8	NPT
PBN 210104	1/2	NPT
PBN 210106	3/4	NPT
PBN 210110	1	NPT
PBN 210112	1 1/4	NPT
PBN 210114	1 1/2	NPT
PBN 210120	2	NPT
PBN 210124	2 1/2	NPT
PBN 210130	3	NPT
PBN 210140	4	NPT

Watertight Coupling

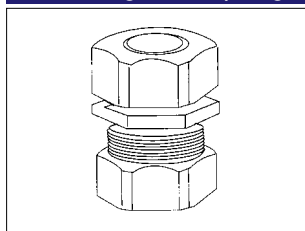

Ref.No.	Size inch
PBC 210103	3/8
PBC 210104	1/2
PBC 210106	3/4
PBC 210110	1
PBC 210112	1 1/4
PBC 210114	1 1/2
PBC 210120	2



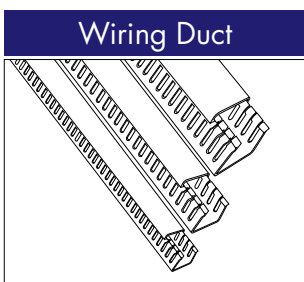

Ref.No.	W x H mm
PMD 0	25 x 25
PMD 0.5	15 x 25
PMD 1	25 x 45*
PMD 1.2	33 x 33*
PMD 1.5	33 x 45
PMD 2	45 x 45*
PMD 2.2	50 x 50*
PMD 2.5	65 x 45*
PMD 3	33 x 65*
PMD 4	25 x 65*
PMD 5	45 x 65
PMD 5.5	60 x 60*
PMD 5.7	65 x 65*
PMD 6	72 x 64
PMD 6.5	33 x 100*
PMD 6.7	48 x 100*
PMD 7	70 x 100*
PMD 7.5	100 x 75*
PMD 8	100 x 100*
PMD 10	150 x 75*
PMD 12	150 x 100*
Colour : Grey	
Length : 1.70, 2.00m	
* 2.00m only	

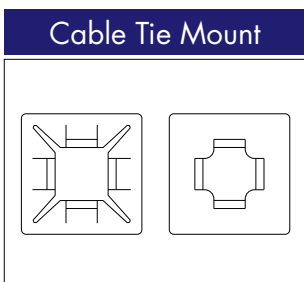
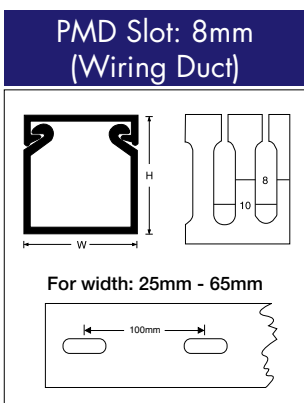

Ref.No.	W x L mm
PCTM19	19 x 19
PCTM28	28 x 28
Colour : White / Black	

PVC-LINK® Natural (White) and black colour nylon cable ties made from U.L. approved nylon 66. Normal service temperature range from -40°C to 85°C. Flammability rating : UL 94V-2

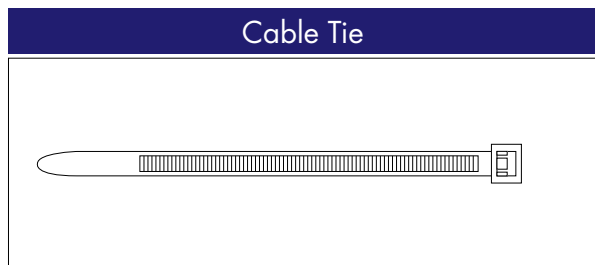

Ref.No.	Length inch	Length mm	Width mm	Max.Bundle Dia mm
PCT 100/25	4	100	2.5	25
PCT 140/36	5 1/2	140	3.6	35
PCT 200/36	8	200	3.6	55
PCT 200/48	8	200	4.8	55
PCT 250/48	10	250	4.8	74
PCT 300/48	12	300	4.8	85
PCT 300/76	12	300	7.6	85
PCT 370/48	14 1/2	370	4.8	102
PCT 370/76	14 1/2	370	7.6	102
PCT 430/48	17	430	4.8	125
PCT 430/90	17	430	9.0	125
PCT 530/90	21	530	9.0	150
PCT 720/90	28	720	9.0	185
PCT 790/90	31	790	9.0	220
PCT 830/90	32	830	9.0	230
PCT 880/127	34 1/2	880	12.7	260
PCT 1030/127	40 1/2	1030	12.7	310
Colour : White / Black				

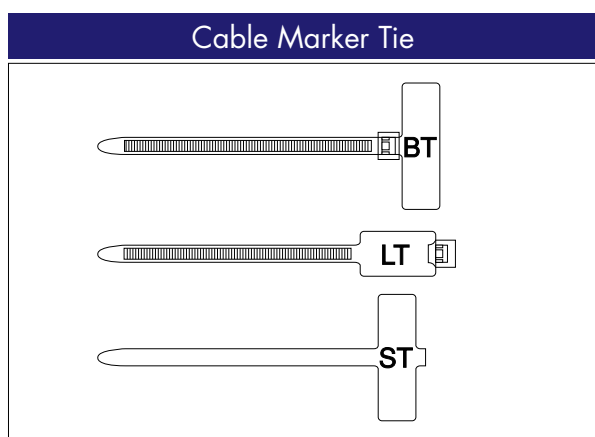

Ref.No.	Length inch	Length mm	Width mm	Max.Bundle Dia mm
PCMT 100/25 ST	4	110	2.5	19
PCMT 110/25 BT	4 1/2	110	2.5	19
PCMT 200/25 ST	8	200	2.5	50
PCMT 200/48 LT	8	200	4.8	50
PCMT 210/25 BT	8 1/2	210	2.5	50
PCMT 300/48 LT	12	300	4.8	75
Colour : White				

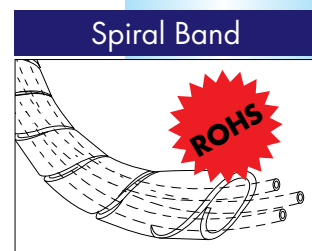

Ref.No.	Size mm	Width mm
PSB 06	6	7.0
PSB 08	8	10.8
PSB 10	10	11.4
PSB 12	12	13.9
PSB 15	15	15.0
PSB 19	19	18.2
PSB 24	24	19.6
Colour : Natural / Black		
Length : 10m		

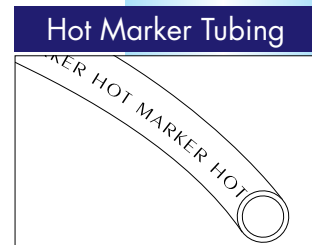

Ref.No.	Dia-mm
PHMT 2020	2.0*
PHMT 2520	2.5*
PHMT 3020	3.0*
PHMT 3220	3.2*
PHMT 3520	3.5*
PHMT 3620	3.6*
PHMT 4020	4.0*
PHMT 4220	4.2*
PHMT 4520	4.5*
PHMT 5020	5.0*
PHMT 5520	5.5*
PHMT 6020	6.0*
PHMT 7010	7.0**
PHMT 8010	8.0**
PHMT 1010	10.0**
Colour : White (Red, Yellow, Blue, Green - upon request)	
Length : 100**, 200* m	



FM Type Marker Strip

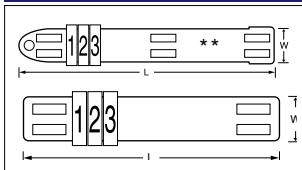

Ref.No.	Digit	Length mm
PMS-65	9	65
PMS-70	10**	70
PMS-100	16	100
PMS-110	18**	110
PMS-135	23	135
PMS-140	24**	140

Colour : Black

FM Type Cable Marker

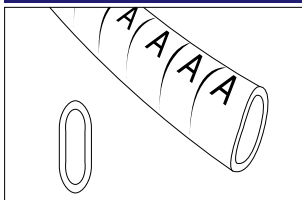

Ref.No.	Marking	Cable Dia-mm
PCMFM	A - Z	3.5 - 7.0
	+ - /	

Colour : Yellow
Coil : 500 pcs

EC Type Cable Markers

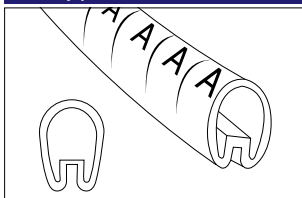

Ref.No.	Dia-Range mm
PCMEC0	0.75 - 3.2
PCMEC1	3.0 - 4.2
PCMEC2	4.0 - 7.2

Marking : + - / or A - Z or 0 - 9
Colour : Yellow
Coil : 1000 pcs

Soft Hole Plug

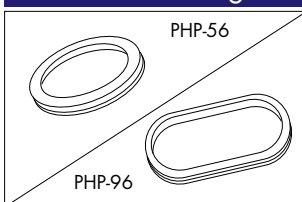

Ref.No.	L x H x T mm
PHP 56	56 x 10 x 2.5
PHP 96	96 x 10 x 2.5

Colour : Black

Copper Busbar Support

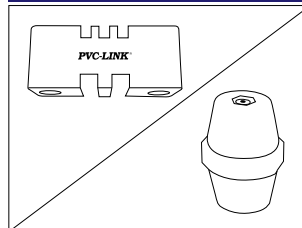

Ref.No.	Size mm
PSM 25-M6	25 x M6
PSM 35-M8	35 x M8
PSM 45-M8	45 x M8
PSM 50-M8	50 x M8
PSM 76-M10	76 x M10
PSM 2/10	2 x 10 / 3 x 7
PSM 3/10	3 x 10 / 4 x 7

Nylon Cable Clamp

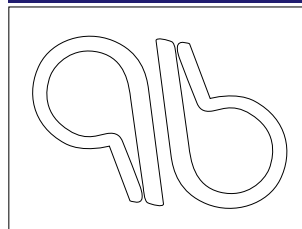

Ref.No.	Cable Dia mm	Mounting Hole mm
PCC UC-0	3.2	4.8
PCC UC-0.5	4.8	4.8
PCC UC-1	6.4	4.8
PCC UC-1.5	7.9	4.8
PCC UC-2	9.5	4.8
PCC UC-3	12.7	4.8
PCC UC-4	15.8	4.8
PCC UC-5	19.4	4.8
PCC UC-6	25.4	4.8
PCC UC-6.5	27.5	4.8
PCC UC-7	31.8	4.8
PCC UC-9	36.7	4.8

Switch Board Lining

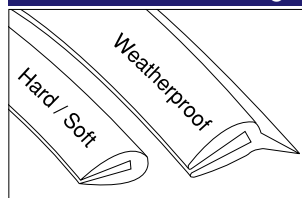

Ref.No.	Usage
PSL-122H	Hard**
PSL-122S	Soft**/**
PSL-125W	Weatherproof*

Colour : Black
Length : 153*, 183**m

End Cap

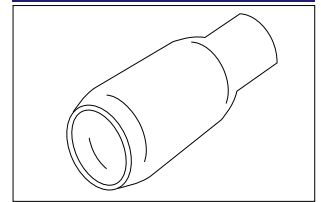

Ref.No.	Cable Dia-mm
PEC 1.25	1.5
PEC 2	2.5
PEC 3.5	4
PEC 5.5	6
PEC 8	10
PEC 14	16
PEC 22	25 & 35
PEC 38	50
PEC 60	70
PEC 80	95
PEC 100	120
PEC 125	150
PEC 150	185
PEC 200	240
PEC 250	300
PEC 325	350
PEC 400	400
PEC 500	500
PEC 630	630

Colour : Red, Yellow, Blue, Black, Green

Hole Snap Bush & Hole Plug

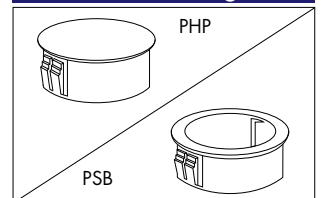

* Hole Plug

Ref.No.	Size mm
PHP-8	8
PHP-10	9.5
PHP-13	13.0
PHP-16	16.0
PHP-19	19.0
PHP-22	22.2
PHP-26	25.5
PHP-30	30.5

Colour : Black

* Hole Snap Bush

Ref.No.	Size mm
PSB-8	8
PSB-10	9.5
PSB-13	13.0
PSB-16	16.0
PSB-19	19.0
PSB-22	22.2
PSB-26	25.5
PSB-30	30.5

Colour : Black



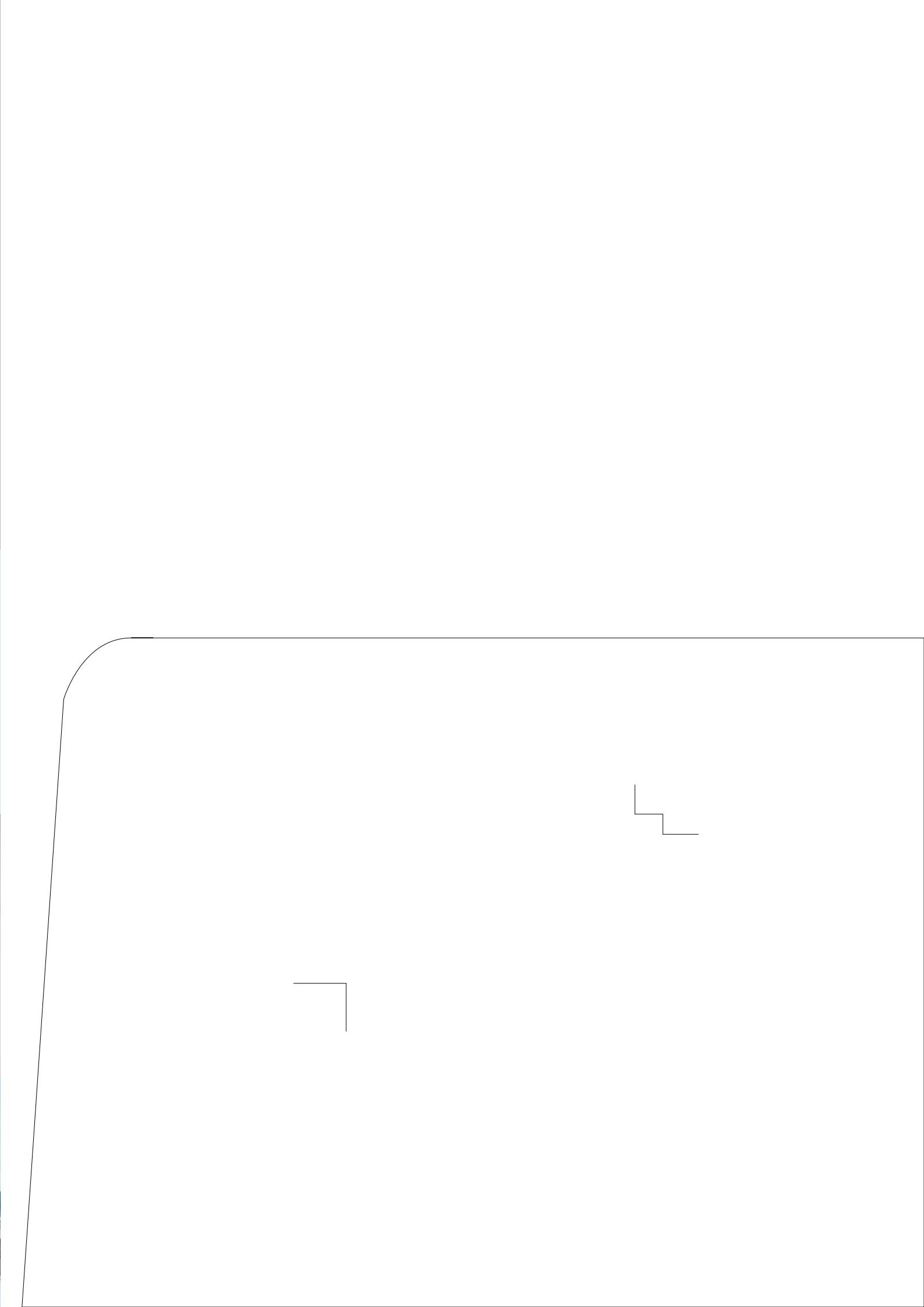



MEGAPOWER MANUFACTURING (M) SDN BHD (543319-X)

Lot 1888, Jalan KPB 7, Kawasan Perindustrian Balakong, Bukit Belimbing, 43300 Seri Kembangan, Selangor D.E, Malaysia.

Tel: (6) 03-8962 3333 (HL) Fax: (6) 03-8962 3322 / 3388 E-mail: enquiries@megapower.net.my

Home page: www.megapower.net.my / www.legrand.com.my